

FLWB8

TILT/ROTATING WALL MOUNT FOR DISPLAYS TO 50lbs

SPECIFICATIONS

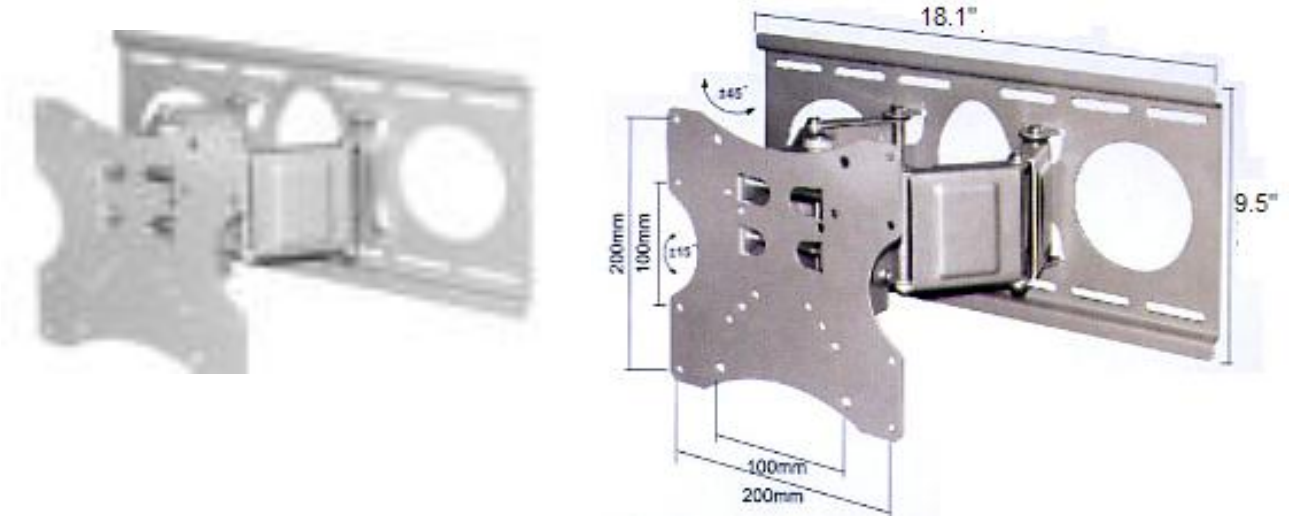

PRODUCT FEATURES

- FOR DISPLAYS TO 50lbs and VESA 75mm/100mm/200mm
- SIMPLE/FAST INSTALL FOR DISPLAYS TO 50lbs
- DOUBLE STUD WALL MOUNT(FOR STUDS 16" APART)
- TILT TO 15degrees
- PUSH FLAT AGAINST THE WALL FOR STORAGE
- 45degree LATERAL ROTATION IN BOTH DIRECTIONS

INCLUDED WITHIN KIT

WALL MOUNT
COMPLETE HARDWARE KIT
INSTALLATION GUIDE

ARCHITECTURAL SPECIFICATIONS

The Wall Mount shall be FEC Model FLWB8 with 45degree lateral rotation, 0Lb max wgt capacity and VESA to 200mm. It shall be installed at all locations as listed per plans. Assembly and install shall be done according to the Manufacturer's install guide. by a professional installer with proper assistance.

Specifications subject to change without notice.